

%66 + EýÁEý#w Ú 6 ©

%66 + eLüF ¼ 1 0 2 6) (7,° EýÁEý#w Ú 6 ©, - ? P0 Ú Ö73, % Ô)æ
 EÉ› EýÁ Ú =EÉ0EýÁ1Óf =EÉ0Eý#w Ú =.#D% Ú ÂEý\$ _ Ú, B Ý ÷ F % FFEýLG
 ž , B98,EÉ0+kÁ,° EÏe Þ , L* , Ç I e Þ , ,° EÉ› # #Â+k#w>
 B 8â() ' +kÁ ó , EÉ› +kÁ99* p 9 f 9> p ¼Lf,, 8â() • 6M, LüF ¼LqÍ . ,,°
 1 0 2 6) (7, 2FRlqÍ û p P , / Ä *] +k#w° Ê+^p > , 8â() F % FFEý-6Š› Ý ‹
 ' +k#w99* >
 8â() p . û p [P P, L * ž , 1¶‹ , % &#qÊ+^Ä : 0 MØ. Ú,° p > , } 315
 ,° %M-] >

[]

- z EÉ› 99* 9a 9, 6] # #Â+kÁ %Eôf 9
- z C», » 5x 0 2 6 ,° 2 FR+kLqÆ P
- z EÏe Þ , L* %B9
- z L†#v&i %B9
- z .#D% Ú Ö73
- z %B9° EÉ› Ú+kÁ
- z %B9° EÉ0 1Óf +kÁ
- z Ñ)" 1 ,° µ 731%
- z %8 ~ C,° '# Ú Ö73

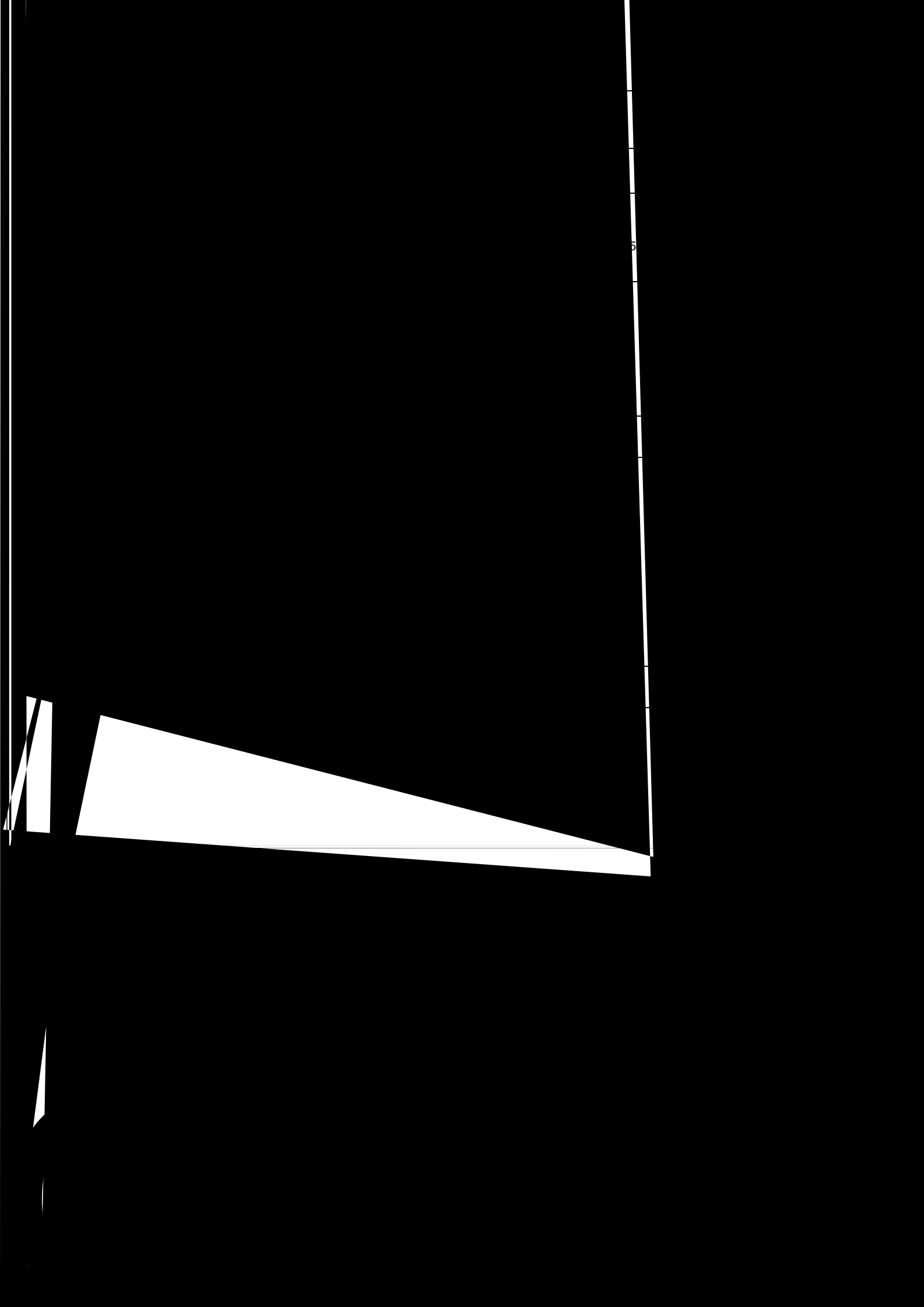

'# Lq 1 RM	-&	
	-\$	
6] 5 \$ _		
6] K7P\$ _ Ü '@ Ü , , 0		
Ž b\$ _ Ü99*		VR

1 RM '# Lqø ! e ^ 8 ' l / #w—, A, <8â() - * Ü '@ Ü ^ 6 • PP [PP R]K Đ,) 5 †C^° x 3&%@#•B í f
 ,° >Mø·# E,° e , ^ ÔL{AôAxD Ê+^c , 3&%9 v , - K Đ Ü , 3&%x ! p . , 2'#EýŠ ! H1• 3VG3<-* Ü § f '#
 Lq°] E >

p9† ' —,

EÉ› +kÁ99*	9 VR 9
5 \$ _99*	f& VR f&

+k"J ø ! #•B —, 9,1 9 &667 Q) &,1 X) &287 X) 7s f& †=Äü >žž ' \$ _Ü99* »?úr

ø !	1\ -	#•B —,	6 E r	@Á r	6] r	† f
EÉ› +kÁ99*	9,1		†			9
EÉ› L +kÁ	9 _{89/2}		†			9
EÉ› +kÁ%)â ó Ü	9+<6					9
M•7+k#w	,4	(1 9	†			—\$
© ã+k#w	,6+' 1	(1	†			—\$
»5α) (7 2 FRlqí	5' 6 21	2 P\$				PŸ
L†#w&i2ô Ü		√07 \$				√07
L†#w&i99*	√07	1 RM				\$
9&3 0 ü+kÁ	9 _{9&3B5()}		†			9
2 93 0 ü+kÁ	9 _{293B5()}					9

			‡				9
293 Ê, L*	7 ₂₉₃						QV
293%)â ó Ü	9 _{293B+<6}						P9
Eÿe P, L*	7 ₆₆	$\&_{667} \quad Q$ 1RM					PV
Eÿe P, L*2ô Ü							
(1 6 e+kÁ	9 _(1B21)		‡				9
(1 ©ã+kÁ	9 _(1B2))		‡				9
EÉ0"ú t +kLq	5',6						N
Eÿ\$ _ Ú&ï	7 _{6'}						f&
\$_Ü Ú%)â ó Ü	7 _{+<6}						f&

1RM 0°E³ —, A e P, L* ø ! A65

#•B —, 9,1 9&/\$03			
Eÿe+kï Q	1RQH		
e P, L* PV			

Eÿe+kï &667 Â e P, L*AxÍ ç E Æ

$$L \begin{cases} s\ddot{a} \bullet \bullet & "x ? \\ \text{—} & P \quad 4 \end{cases}$$

, ÒC ÖEÿe+kï , 8â() »5Eÿe P, L* 7_{66B/7p} PV> „17 e »5 α^0 +k#v\$Æ, +k#w] E4Ü X\$>

1RM L†#v&ï ø ! A65

L†#w+kLq 5 N								
L†#v&ï ,07 \$								

L†#w+kLq 5 ÂL†#v&ï ,07AxÍ ç E Æ

$$wL \frac{SS}{\text{—}} : \bullet 3;$$

Ý I | 4

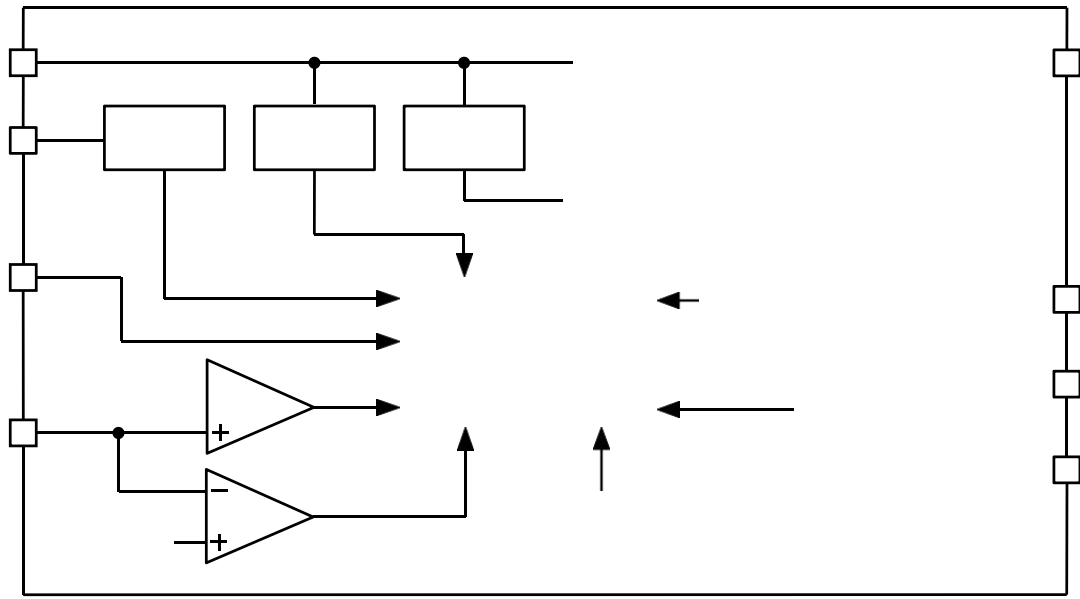

4 Ý I | 4

图 1 (续)

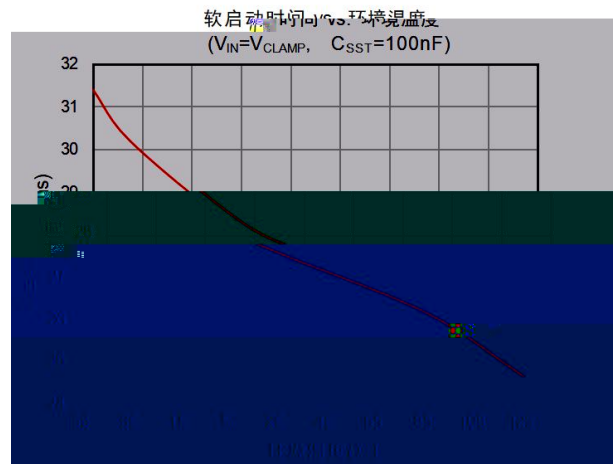
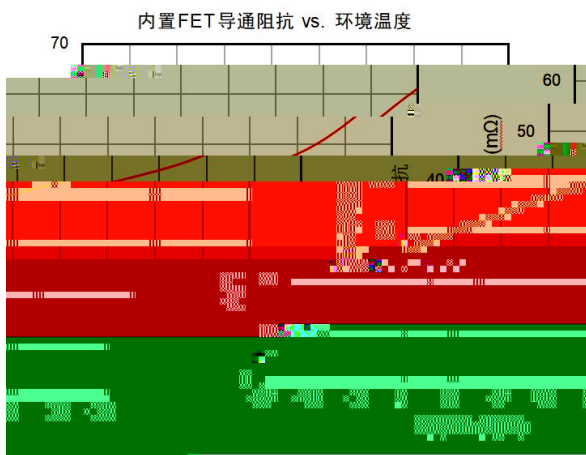
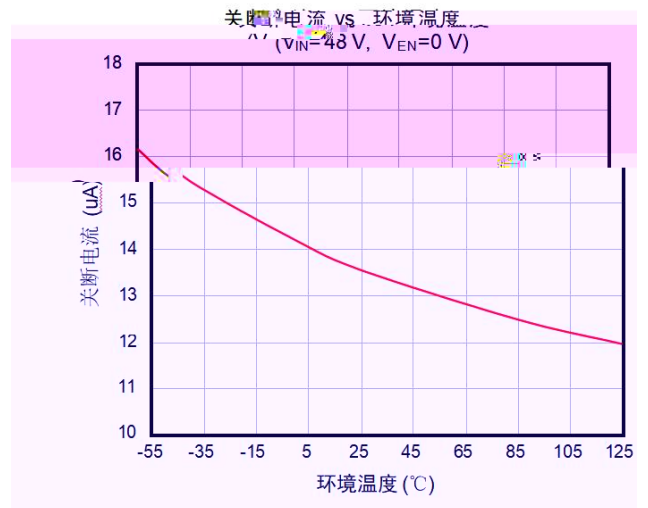
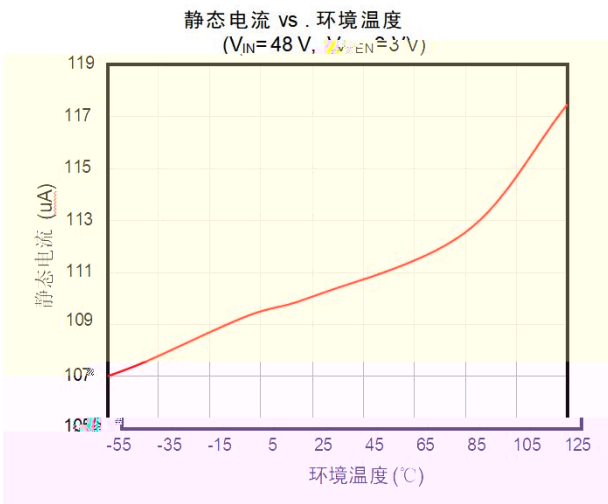
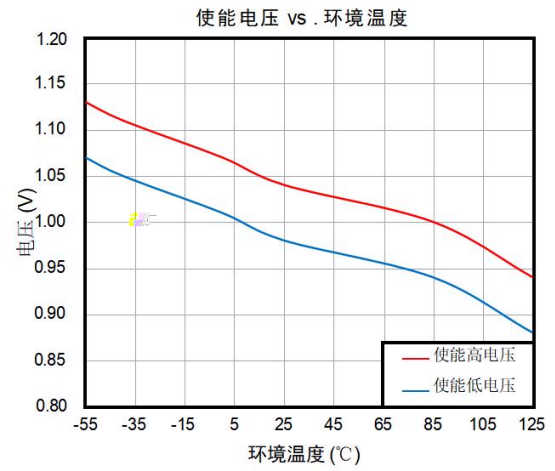
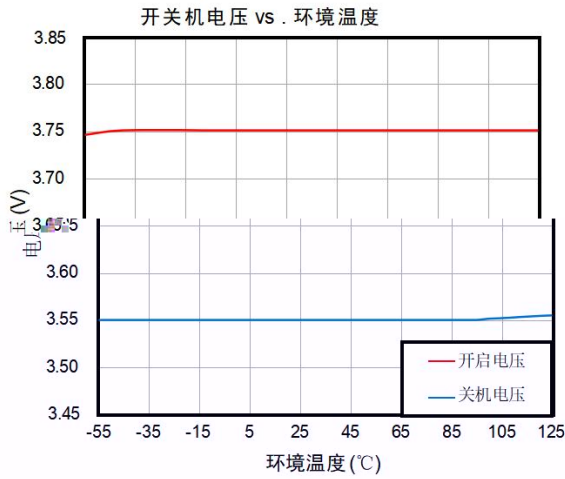

Startup from Enable
($V_{IN}=48V, I_o=5A$)

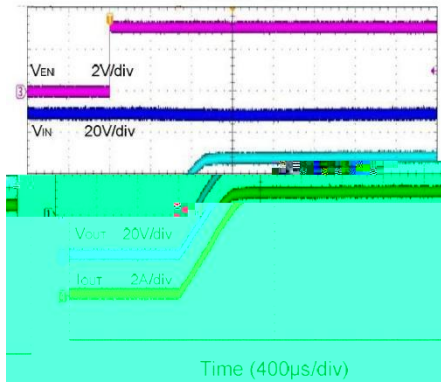

Shutdown from Enable
($V_{IN}=48V, I_o=5A$)

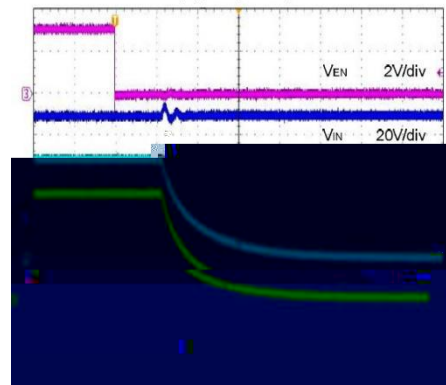

Startup from V_{IN}
($V_{IN}=48V, I_o=5A$)

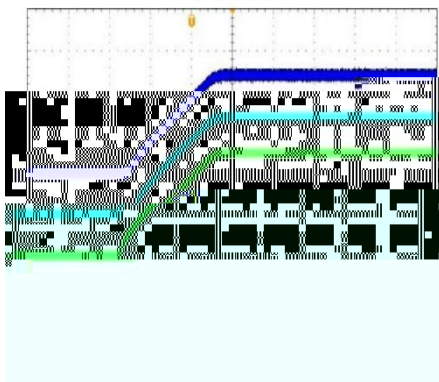

Shutdown from V_{IN}
($V_{IN}=48V, I_o=5A$)

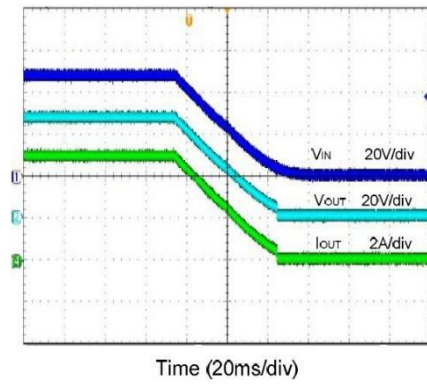

OVP Response
($R_1=432k\Omega, R_2=10k\Omega, R_3=390k\Omega, R_4=10k\Omega$)

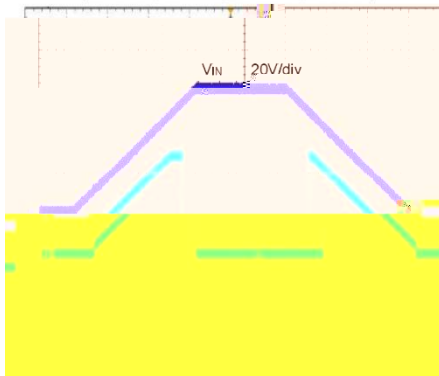

Short Circuit Protection
9L 9 & 667 Q

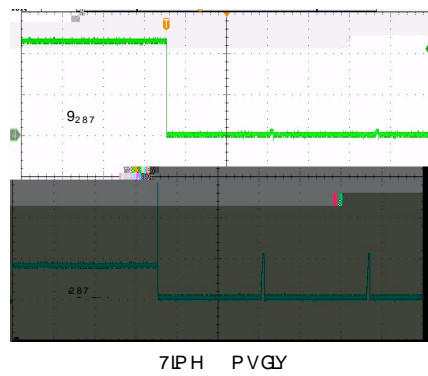

Ö* < F&

%66 + eLüF ¼ 1 026) (7,° EyÁEy#w Ú6 ©, - ? P0 Ú Ö73, % Ö)æÉÉ EyÁ Ú =EÉ0 EyÁ1Óf =EÉ 0 Ey#w Ú =.#D% Ú ÁEy\$ _ Ú , B Ý ÷ F % FFEyLG ž , B9, EÉ0+kÁ,° EYe P , L* , Ç I e P , ,° EÉ # #Á+k#w>

EÉ EyÁ Ú ÁEÉ0 EyÁ1Óf

%66 + - ? EÉ EyÁ Ú ÁEÉ0 EyÁ1Óf,° Ö73>

EÉ EyÁ Ú&i AE9293 9 5 5 5

EÉ0 EyÁ1Óf &i AE9&/§03 9 5 5 5

%EÉ +kÁ ,, Ä 9&/§03 JQ ÄEÉ L +kÁ , , EÉ0+kÁD LÄEÉ +kÁ Ç %EÉ +kÁ ,, Ä 9293 JQ Ä 9&/§03, EÉ0+kÁ <>á1Óf ^ 9&/§03 Ç , ÒEÉ +kÁQ Ä 9293, <@ EÉ EyÁ Ú , »G Ö)½1x©ã >

EYe P , L*AÖ

#*B —, 0°E³, 9,1 9&/§03				
EYe+kī Q	1 RQH			
e P , L* PV				

EYe+kī &667Ä e P , L*Axi ç E AE

$$L \begin{cases} s\ddot{a} \bullet \bullet & "x ? \\ \text{---} & P \quad 4 \end{cases}$$

, Ö C ÖEYe+kī , 8ä() »5EYe P , L* 766B /7p PV> „17e »5ä,° +k#w\$AE +k#w E4Ü X\$>

L#w&iAÖ

L#w&i,°] EFPEy √07 7P/ * 1' ,° L#w+kLq 5 > AÖ, 5 ,° Lqr ÄL#w&i ,/07

Axi ç E , A AE

$$wL \frac{SS}{:} : \bullet 3;$$

0Aä6 EL#w&iAÖC,, Ä \$, 6] L#w&iAÖCC:Ey \$>

EÉ +kī

0Aä8ä() ,1 7PÄ * 1' • L*8) G> Ú X) ,° L-+-+kī > ÖL{ Ê+^c , %EÉ 465<E'Kμ° û ë A , 0AäÖ ÖEÉ +kī i H , F m73? ~ EÉÉ0 Ey#wL.#D% , 8ä() »G Ö)½1x0.'l ©ã ^EÉ 1%)æ° +kÁEyè De9→ , ÒEÉ 1%kÁ e9-Ey] C> Ey8ä() 6] 6F r , 8ä() < P • ...>MØ.# E,° e , +gÄL-+-+kī,° i H PLÁv v μ ,° -* #w+kÁ6Bo , !š ÖL{+kD% ,° +kī i H M69<†f -* #w...Á([] \) ,° § >

EÉ0+kī

0Aä^8ä() 2877PÄ * 1' • L*8) G> Ú X) ,° L-+-+kī , - J - 6Ní6ì(0 Ä · 1x> ÖL{ Ê+^c , %EÉ0 465<E'Kμ L U] CUE³,° û ë A , 0AäÖ ÖEÉ0+kī i H , %8ä() »G Ö)½1x0.'l ©ã , , - ,° 6ì(0 Ä · 1x73U p CUE³+k#w Ñ5# #WFD% B , E¹] ,° EÉ0+kī i H ? ~ f Fμf ¼ %73^8ä() EÉ0 1%)æ° CÜ+kÁ e9→MØ.# E,° e , +gÄL-+-+kī,° i H PLÁv v μ ,° -* #w+kÁ6Bo , !š ÖL{+kD% ,° +kī i H M69<†f -* #w...Á([] \) ,° § >

3 & % / D RXW9 v ? . "x

66 +, 9 v-. / 11', p 9i í 6 ©, 73, 0Aäø69 A, i # Æ

A=v ? Ö)½C!4ö sH, .# Å ó >

p 9i í E¹³, #] 73, 0Aä?+^Z x L x 3&%ø μ , B , D8â() ,1Â 287. F, 3&% K Mø . sH Ô Ö Ð Ü Â Mø%
 EÉ +kî & Mø . sHMF 8â() ,1Â * 1' , - ° F, Mø Mø . sH E >

EÉ +kî & Mø . sHMF 287Â * 1' , Fμ f EÉ 0465-É¹Kμ^ EÉ 01%KC-, e9→

287Â * 1' • L*M6 - 6Ní6ì(- 0 Â · 1x' , % ^ U] CUE³ —, A Ñ5##wFD% B , ? ~Fμ f %73^8â() EÉ 01%)æ°
 CÜkÁ e9→

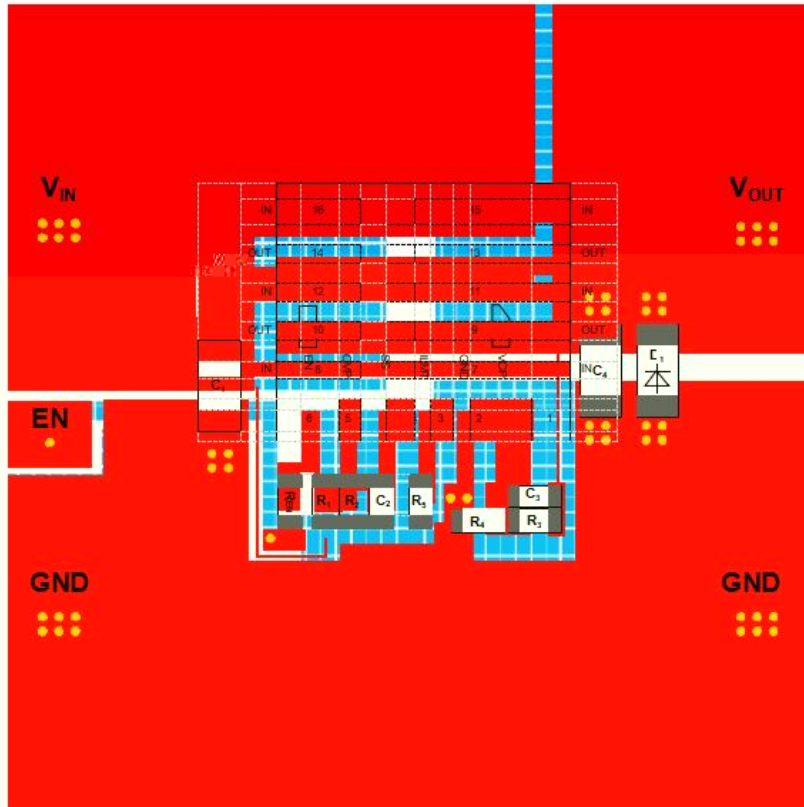

7>ûp .

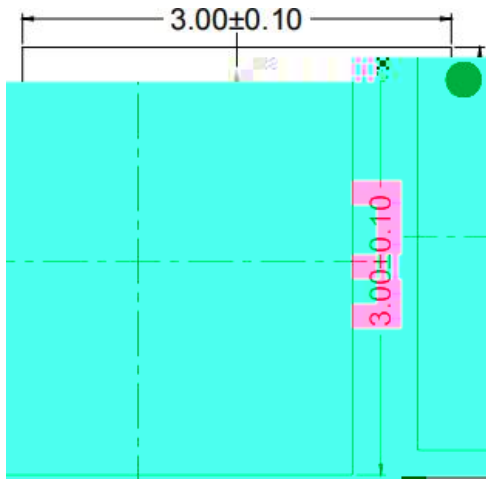

%?ü4

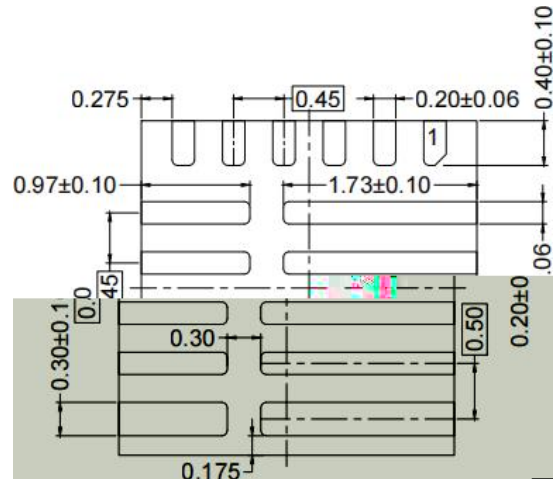

Ë?ü4

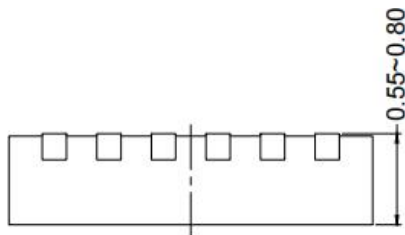

Ý?ü4

ÆEv ? p . < f p PP

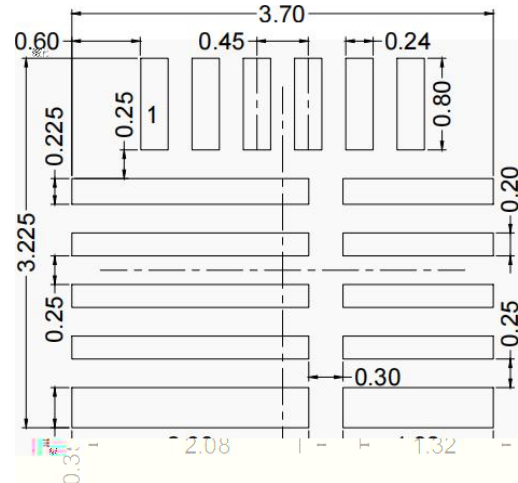

3&% 0Aäp . ´ û Ñø69µ